

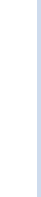

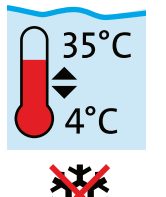

<p>FI $\leq 30\text{mA}$ 230 V~ 5 W IP 68</p> 	  	 
---	---	--

i



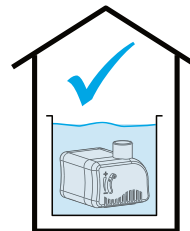

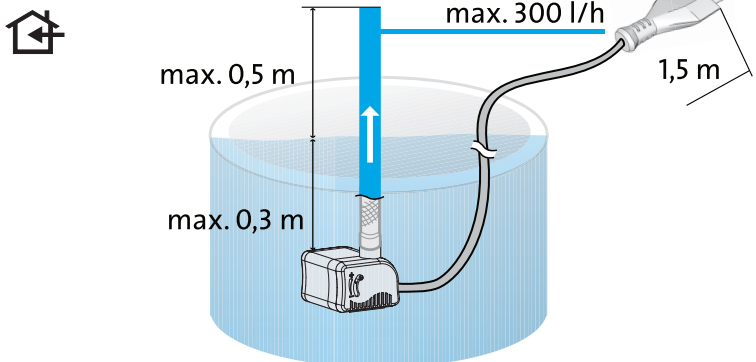
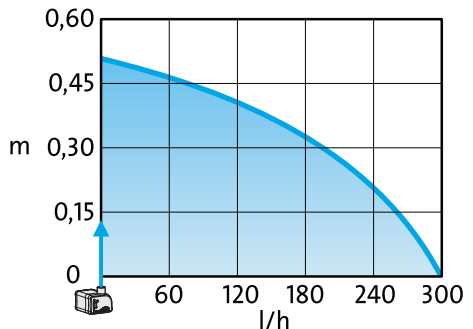
1

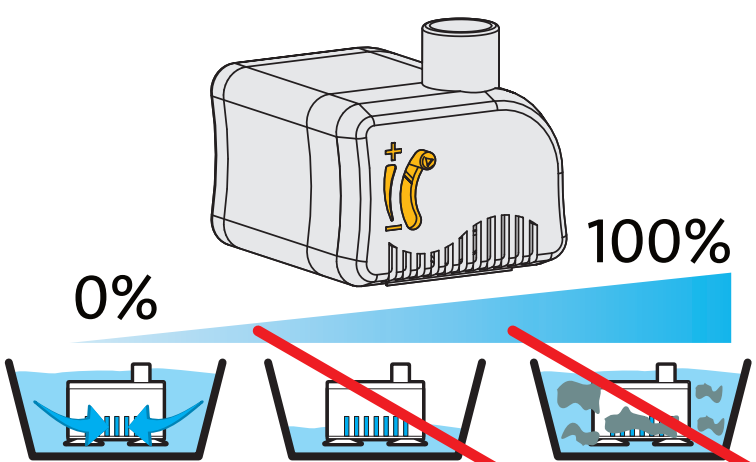

Anwendungsbeispiel

i



2

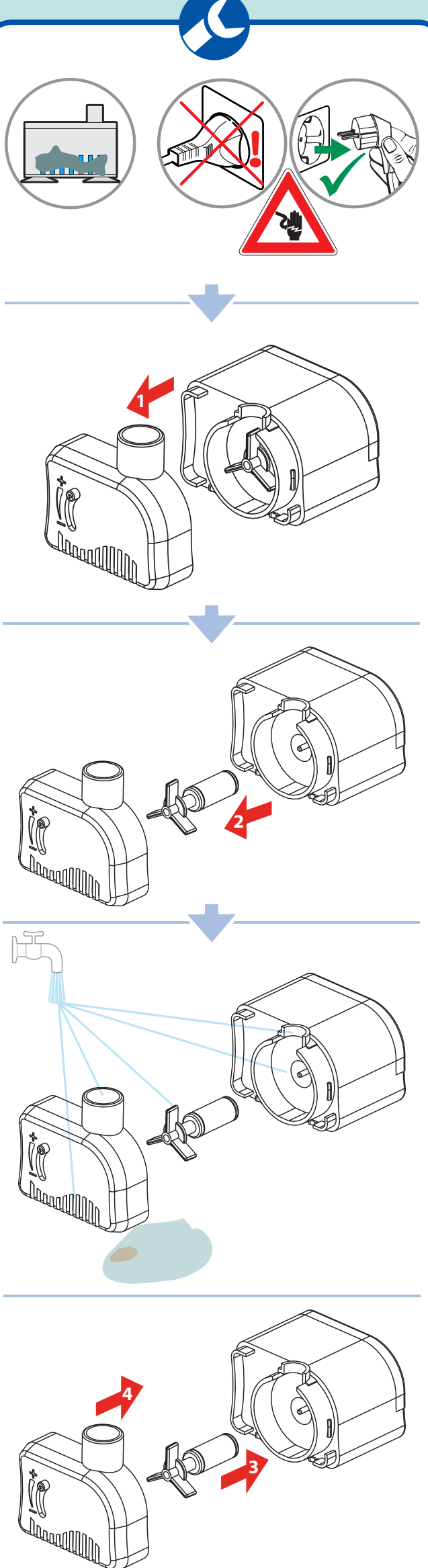

2

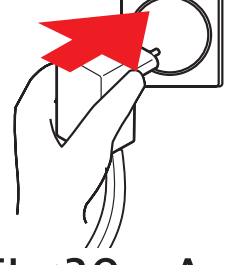
FI $\leq 30\text{mA}$
230 V~



P300-i
0-300 l/h · 5 W

